

# INTERNAL FOLDING ROOM DIVIDER SETS- 5L

Assembly Instructions  
Bespoke and Standard Sizes

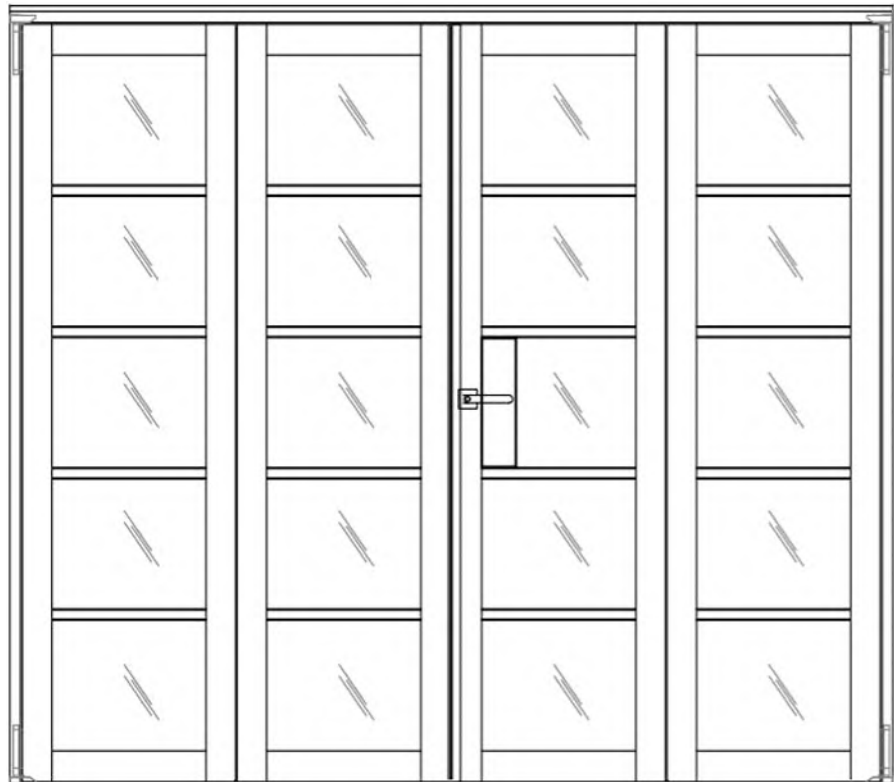

# About your internal folding room divider set

All our internal folding doors and frames, single glazed units and hardware components are guaranteed for a full 15 years against the occurrence of manufacturing faults, all subject to correct installation and regular maintenance and care in use as detailed below.

## Door and frame components

All our timber components are manufactured using the latest technology to reduce warping or twisting. They are constructed using an engineered wooden core, solid wood lipping's and faced using real wood veneers.

No two trees produce identical grains or colour of wood, and this adds to the beauty of a natural product. We therefore cannot guarantee that all door and frame components will look exactly the same in grain and colour.

Veneers are natural products and prone to deterioration if not fully sealed with superior quality finish. If moisture penetrates the finish this may cause cracks to appear or splits.

Unfortunately, we cannot change the properties or performance of the timber components which are natural products. We cannot therefore accept claims for any variation in the components, or cracks or splits that may appear due to moisture going into the timber. If all faces and edges, including the tops and bottom edges of the doors, are not fully sealed then this can cause excessive movement in the doors due to temperature changes and natural moisture in the air. What is more, warping of wood is not a defect if it is not more than 1/4 inch (6mm) when it is in its installed position.

## Protective finish and maintenance

### Primed plus door sets

Our black primed plus door sets have been primed with a polyurethane wood finish. Whilst this base coat finish offers good protection against natural moisture in the air and general temperature changes, a final finish can be applied on installation.

All internal doors sets must be checked every 2-5 years for deterioration in the finish, and re-coated as and when necessary. Moisture must not be allowed to penetrate the timber. The length of time between re-coating depends greatly on the environment / location the doors are installed in. The coating may require more regular attention if installed say between a kitchen and living area or separating a lounge and dining area with a log burner, or directly next to a radiator due to regular varying temperature changes and moisture rich environments.

We do not recommend re-finishing with any other finish other than polyurethane finishing systems. The RAL (colour match) paint code is;

-Black RAL 9011 Graphite Black - 8-10% Gloss level

### Unfinished door sets

If you have bespoke ordered an unfinished oak door set the door set must be fully finished according to our guidelines BEFORE the door set is installed. Failure to do so will invalidate the guarantee.

Please note, that use of steel wool or allowing steel or iron fragments to come into contact with the untreated oak timber or veneers may cause oxidisation resulting in black staining.

Internal unfinished oak door sets must be finished with an internal polyurethane varnish or paint in your preferred colour and gloss level. This should consist of a minimum of 3 coats to ALL faces and edges of the doors and frame components to ensure the product is fully sealed, including the tops and bottom edges of the doors. If you are looking for a durable and more natural finish, we recommend using Dulux Trade clear polyurethane varnish in a satin finish. It is important that you have tested and checked that you are happy with your choice of finish before applying to your door set. Please note, even clear finishes will darken the timber from its original appearance.

**IMPORTANT: Do not use any oil or wax based finishes, or any quick drying products such as (but not limited to) Ronseal, or any finish other than a polyurethane finish as this will invalidate your guarantee.**

See pre-finished doors sets section for maintenance advice.

### Single glazed units

Tempered glass means it has been toughened to be up to five times stronger than normal glass. It is unusual to break such strong glass, but sharp objects hitting the glass at certain points can cause breakage. Tempered glass is also known as safety glass. This means that if it breaks it will shatter into smaller fragments which are less likely to cause injury, unlike non-tempered glass which breaks into large, sharp fragments.

Glass must be regularly maintained and cleaned. This can be done using a mild solution such as washing-up liquid diluted in water. Do not use abrasive cleaning solutions as this may cause scratching.

Visual distortions caused by reflections in toughened glass are a natural phenomenon and not a fault.

Toughened glass is acceptable if bubbles or blisters, fine scratches no more than 2.5cm long and / or minute particles are neither obtrusive nor bunched. The glass used is a processed glass therefore certain blemishes are unavoidable.

For carrying out a glass inspection, stand at least 3 metres away from the glazing, view at 90-degree angle and look directly through the glass unit(s). The glass must be viewed in natural daylight but not with the sun directly on it.

## About your internal folding room divider set (cont)

### Hardware components

The hardware in your internal folding door set can deteriorate from everyday use. That's why regular maintenance of your door hardware is important.

We require that the below minimum maintenance is carried out as often as necessary to prevent deterioration. As a guideline, we recommend that this maintenance is done every six months otherwise your guarantee will not be valid.

#### Hinges and bolts

Using a microfibre cloth, wipe down the visible surfaces with warm soapy water and then rinse off by wiping with a clean, damp cloth. Applying a thin film of a light machine oil or silicone spray, wiping with a dry cloth to remove any excess, will help to maintain the original lustre of the metal finish. Be careful not to get these liquids on the timber as this can cause staining.

#### Door latches and handles

The handle and latch should operate just as smooth with the access door in the open position as what it does when it is fully closed.

It is important that if you feel any resistance when using the handle, you do not continue to operate the doors as this may eventually cause the latch to fail and will invalidate your guarantee.

All moving parts should be lubricated with silicone spray.

The handles should be regularly cleaned with a soft damp microfibre cloth to remove any dust or grime, taking care not to scratch the surface.

If you experience problems opening and closing your doors, first eliminate any actual latch problems by opening the access door and pressing the handle downwards. If this can be done, and the latch is moving in and out, the latch is operating normally. The problem is likely to be due to incorrect door alignment / adjustment.

Please refer to pages 15 & 16 for correct spacing and adjustment guidance.

## Introduction to Assembly

### *QUICK GUIDE*

Your internal folding doors are supplied with the frame unassembled and in 3 pieces, ready for assembly on site. Thresholds where ordered will also be supplied loose.

Our standard doors are all pre-glazed and our black primed plus finish is base coated, therefore additional finishing may be required on site prior to assembly.

Every internal folding door set is factory pre-machined for hinges, latch, striker plate, spindle, bolts and seals.

When you receive your internal folding door set, to install it, assemble the frame then install it into the opening using the fixings and drill bits supplied.

Attach the hardware to the doors and install the doors into the frame.

Check the final spacing and operation of your internal folding doors, and should adjustment be needed refer to the ' Adjustment of your doors ' section of these instructions, pages 15 & 16.

**Full and detailed installation instructions are contained  
within this Instruction booklet**

# Contents

**IMPORTANT:** Please check the contents of the packages to ensure that all parts are present and in good condition before booking your installation

## Timber parts

Our 4 door internal folding room divider door sets come as standard in one size, 2.4m wide. Each door set comprises of;

- Qty 1 x Door 1 - Pivot door
- Qty 1 x Door 2 - Access door
- Qty 1 x Door 3 - Middle door
- Qty 1 x Door 4 - Pivot door
- Qty 1 x Frame pack (includes 1 x left jamb, 1 x right jamb, 1 x frame head, 1 x astragal mullion)

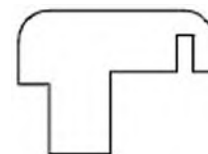

Astragal mullion  
32mm x 23mm x 1967mm  
(sectional view)

The following product codes cover the 2.4m door set available as standard

<b>Door 1</b> Pivot door	40INS5LBCB08-1
<b>Door 2</b> Access door	40INS5LBCB08-2
<b>Door 3</b> Middle door	40INS5LBCB08-3
<b>Door 4</b> Pivot door	40INS5LBCB08-4
<b>Frame pack</b>	40INS5LBCB08-5

## Hardware

### Top pivot

Qty 2  
(supplied with Qty 8 Torx screws and Qty 4 dome headed Phillips screws)



### Striker plate

Qty 1  
(supplied with Qty 2 x 3/4" x 6s pozi wood screws)

189-56RFKEEP



### Bottom pivot

Qty 2  
(supplied with Qty 8 Torx screws, Qty 4 dome headed Phillips screws and Qty 2 end cap)



### Flush bolts

Qty 6  
(supplied with Qty 2 x 30mm screws, Qty 2 x 20mm screws and Qty 2 x striker plates per bolt)

DDDB006-8BLK



### Half offset hinge set

Qty 2 (3 per set)  
(supplied with Qty 48 Torx screws)

E222FB22MWDT5

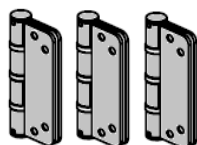

### Black pozi wood screws

Qty 5

ASP030020031



### Tubular mortice latch

Qty 1  
(supplied with Qty 2 3/4" x 6s pozi wood screws)

185-55RFBODY-B

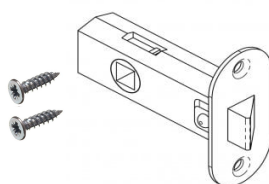

### Long striker plate

Qty 2  
(supplied with Qty 2 x 20mm Philips screws per plate)

BSPLATE



## Contents (cont)

### Installation kit

A) M5 x 70mm Hardened steel wood screws  
Qty 6



B) Hardened steel direct frame fixings  
Qty 15



C) HSS long drill bit 6.5mm x 148mm  
Qty 1



D) SDS drill bit 6.5mm x 210mm  
Qty 1



E) 1/4 Hex T30 insert bit  
Qty 1



F) Direct frame fixing cover caps  
Qty 15



K1570911(38)INSPIRE

G) 7mm Masonry drill  
Qty 1



H) M4 x 40mm pozi screws  
Qty 4



I) 1/4 Hex pozi no.2 insert bit  
Qty 1



J) Small flat head screwdriver  
Qty 1



K) 14mm spanner  
Qty 1



L) Plugs  
Qty 4



M) PH2 bit  
Qty 1



### Seals

AQ21 Draft seal 2.3m  
Qty 4



AQ21BLK2.3

Brush seal  
Qty 1



BLACKBRUSHSEAL

5mm Bubble seal 2.3m  
Qty 3



R9885

### OPTIONAL EXTRA

Metal door holder  
Qty 2

DDDS035



## Preparing the site

When preparing the site, please prepare the brickwork / stud wall opening to be 10mm more in height and in width than the outside assembled frame size.

It is essential that all the internal surfaces of the brick / stud work are level before installation. Please ensure that all dimensions are correct for installation before proceeding, as the door set must be installed square and level into the opening.

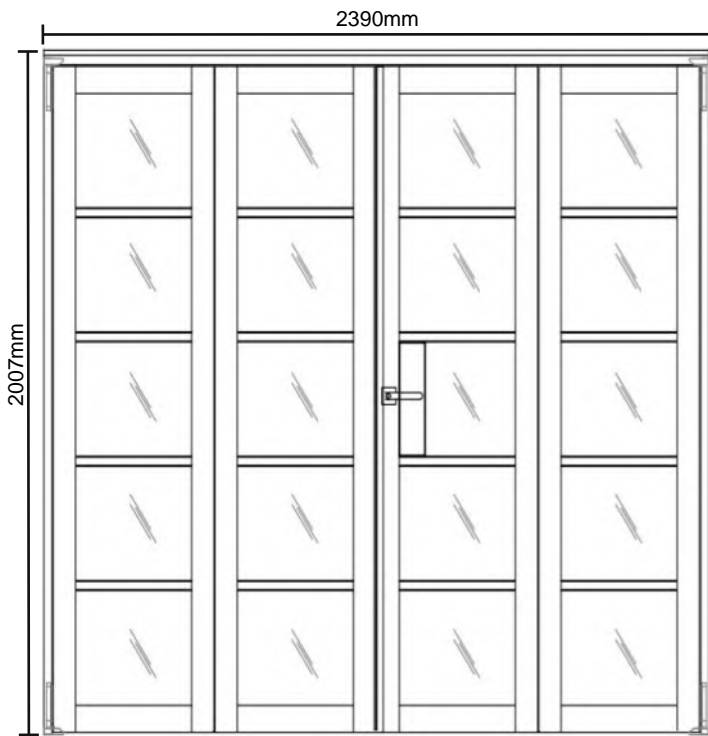

(Based on standard door set without optional threshold)

Brick / stud work opening = Frame width + 10mm

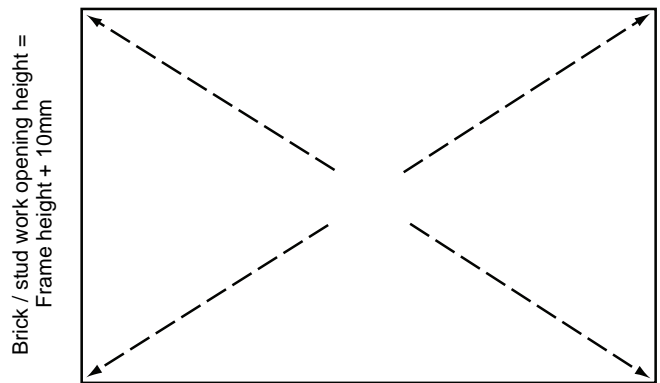

**Standard sized internal folding door sets outer frame dimensions are as follows;**

2.4m Door set = 2390mm wide x 2007mm high

**The brick / stud work opening (based on fished floor level) sizes are;**

2.4m Door set = 2400mm wide x 2017mm high

**VERY IMPORTANT.**

The frame and doors are designed to be installed **ON TOP OF THE FLOORING** or floor covering. If installing onto a sub floor, which will then have flooring on top of it, you will need to install the frame allowing for the thickness of the flooring / covering.

## Opening options

Our standard 4 door internal folding door sets are reversible, meaning you can choose either of the central doors to be your main daily access door, simply by rotating the doors 180 degrees. (Not inside out, but upside down so the top of the door becomes the bottom and vice versa.)

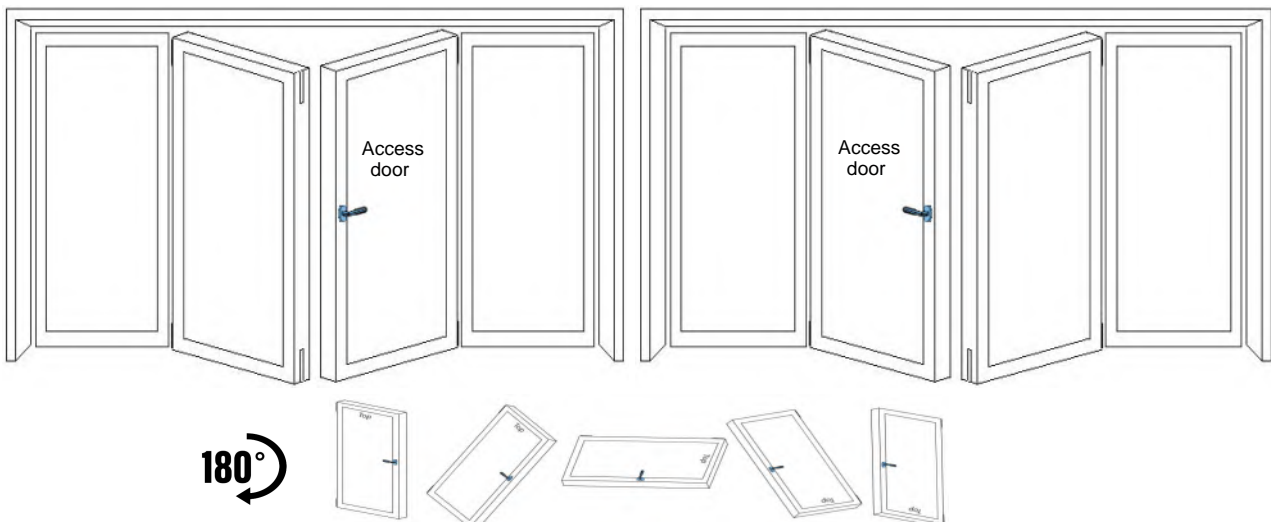

# Opening options (cont)

## Door configuration

### Right opening configuration

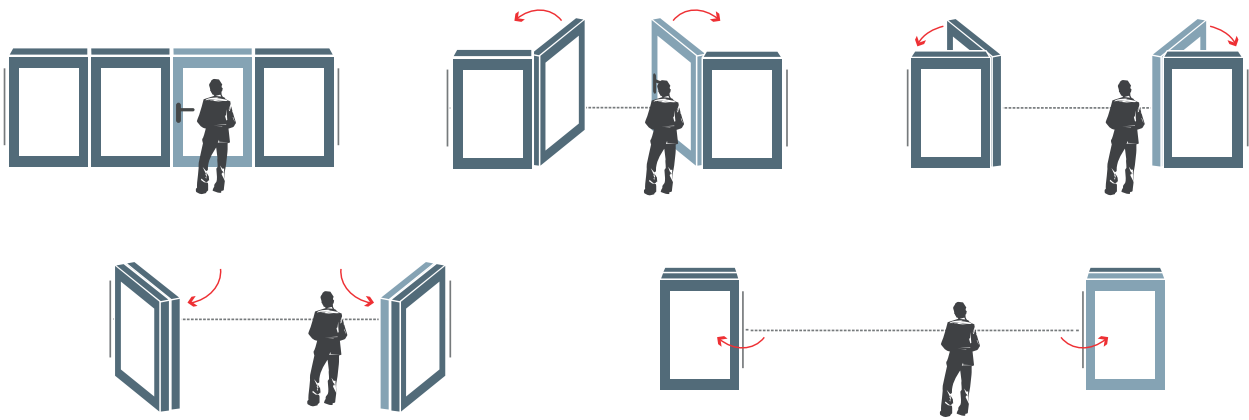

### Left opening configuration

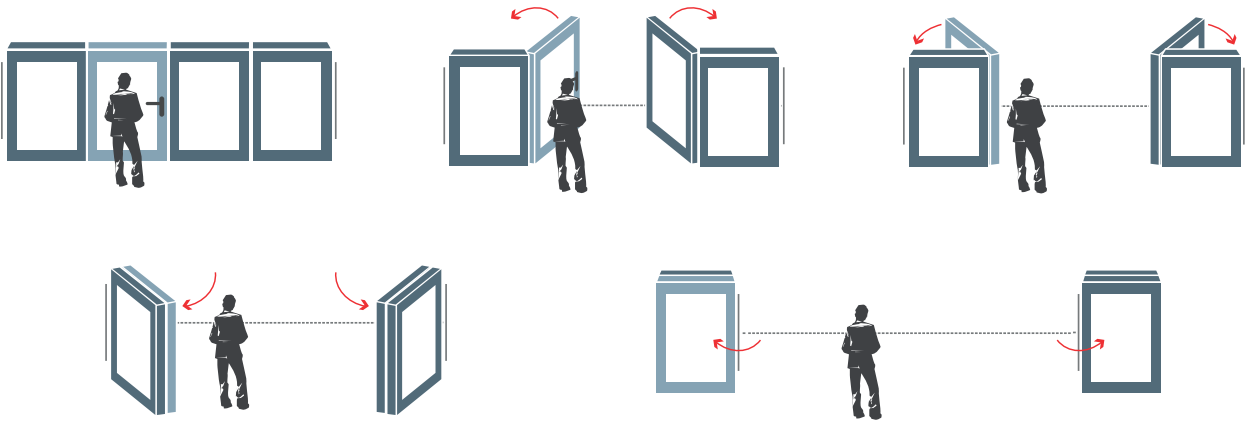

## Opening direction - right opening

The direction the doors open towards will be determined by which way round you install the outer frame into the opening. The same frame can be installed to have the doors opening towards or away from you by rotating the assembled outer frame 180 degrees.



Example shows right opening coming towards you

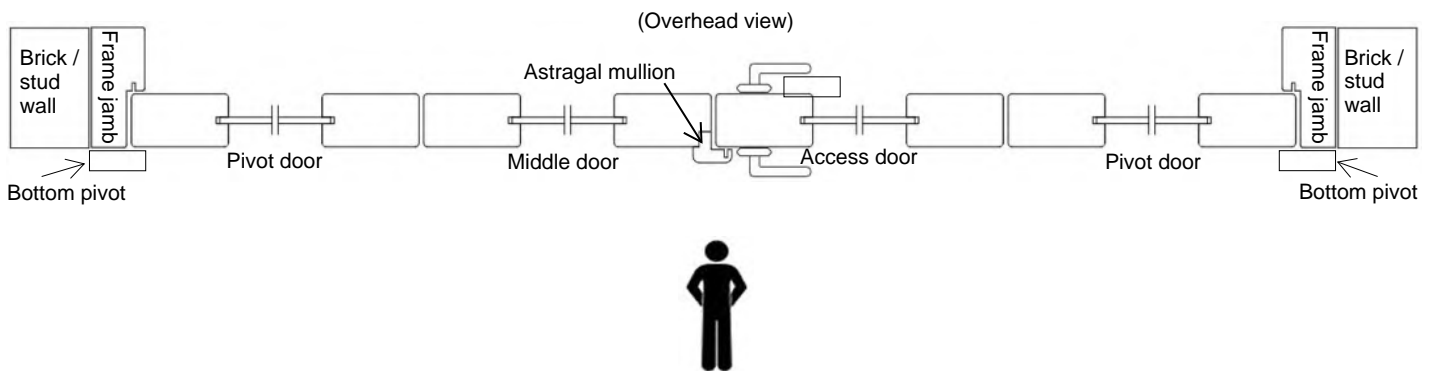

# Opening options (cont)

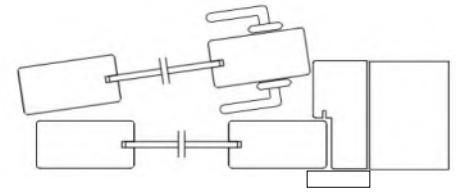
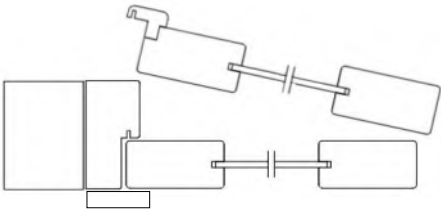

Access door and middle door both open

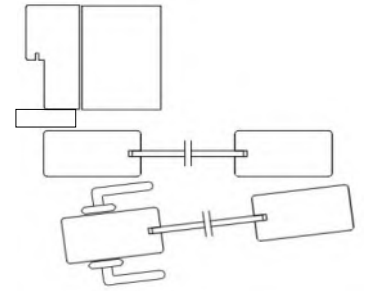
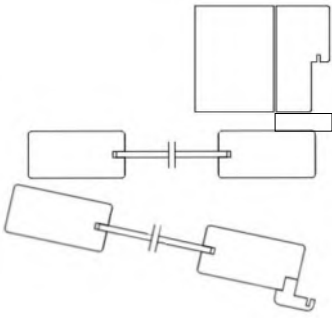

All doors fully open and folded back round against the wall

## Example shows right opening, opening away from you

(Overhead view)

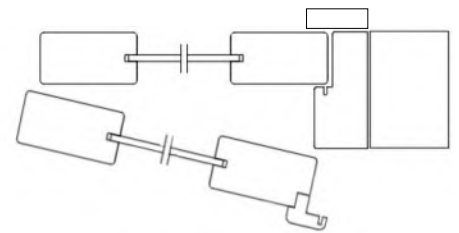
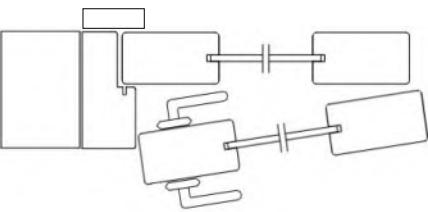
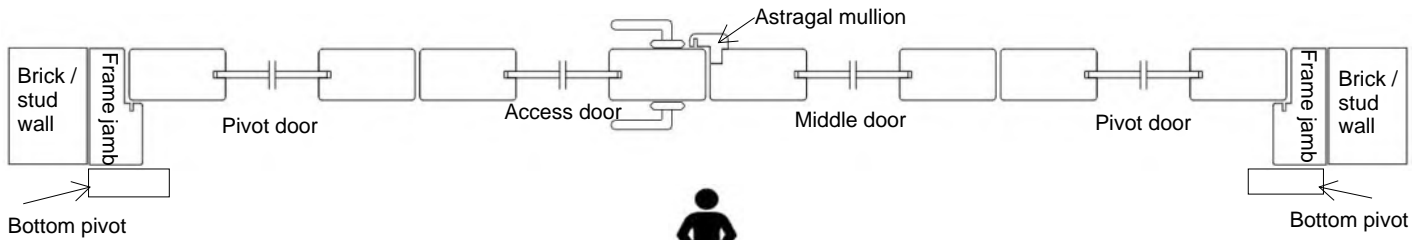

Access door and middle door both open

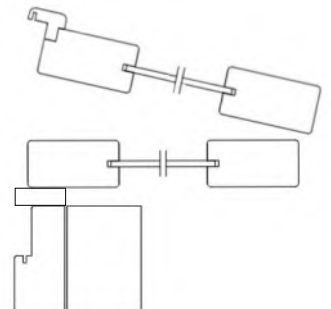
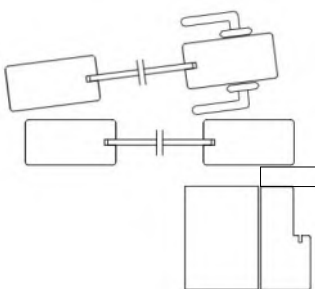

All doors fully open and folded back round against the wall



# Opening options (cont)

## Opening direction - left opening

Example shows left opening coming towards you

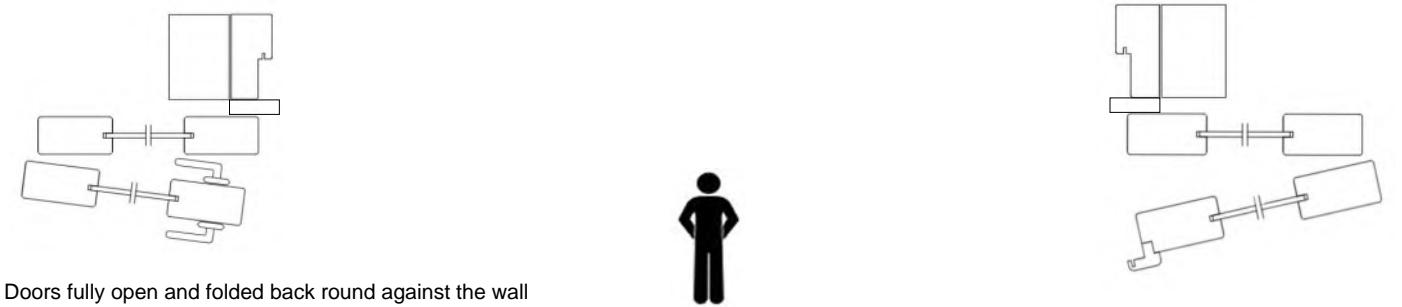
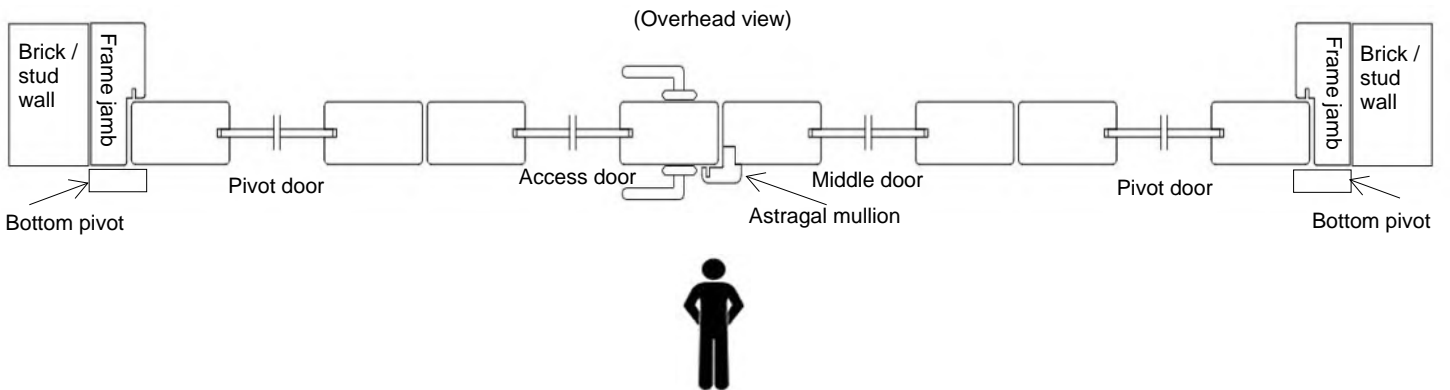

Example shows left opening, opening away from you

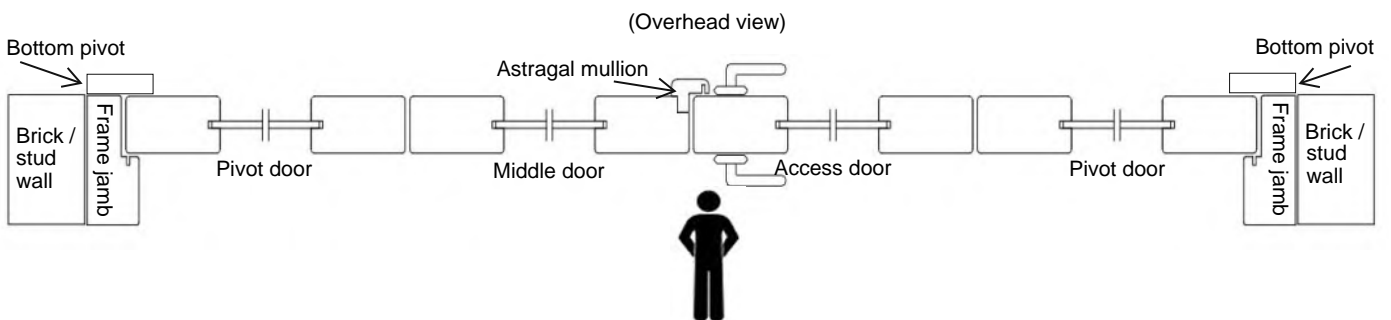

## Opening options (cont)

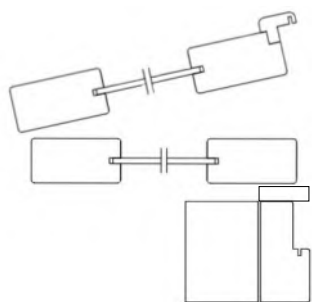

Doors fully open and folded back round against the wall

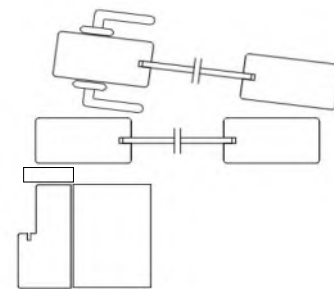

## Assembling the frame

Assemble the jambs to the frame head using the M5 x 70mm wood screws (A) and Pozi no.2 insert bit (I), fixing through the pre-drilled holes, with Qty 2 fixings at each end.

**IMPORTANT:**  
Fit the brush seal into the frame head **BEFORE** fixing into the opening for ease.

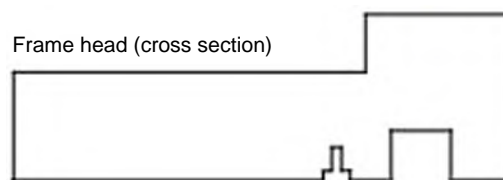
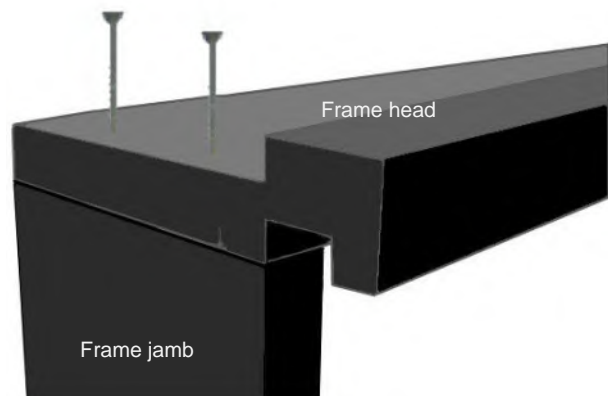

Frame head (cross section)



Brush seal

Push the brush seal into the pre-machined groove in the frame head by hand. If you cannot do this by hand, try using the rubber end of a mallet or hammer.

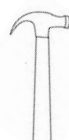

## Installing the assembled the frame

The frame can be rotated 180 degrees prior to installation to alter if the doors will open towards you or away from you, see pages 7-10 for diagrams.

Proceed to install the assembled frame.  
*It is critical that the frame is fitted square and level.* Ensure the frame is installed straight and square. Use shims / packers between the frame and the opening.

The height (H) must be the same across the whole width of the opening.

The diagonals must be the same.

**It is very important the frame jambs are level.**  
**Place a spirit level on the face and sides of each jamb and check before proceeding.**

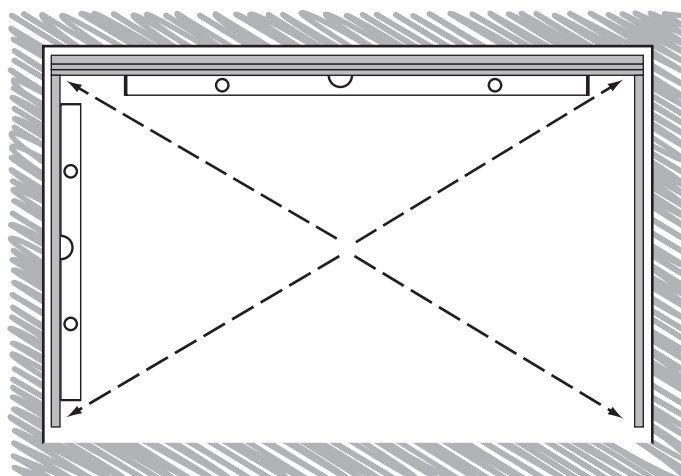
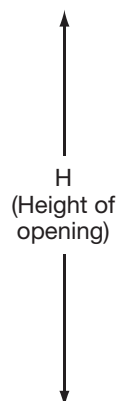

## Installing the assembled the frame (cont)

(Cross section of installed frame)

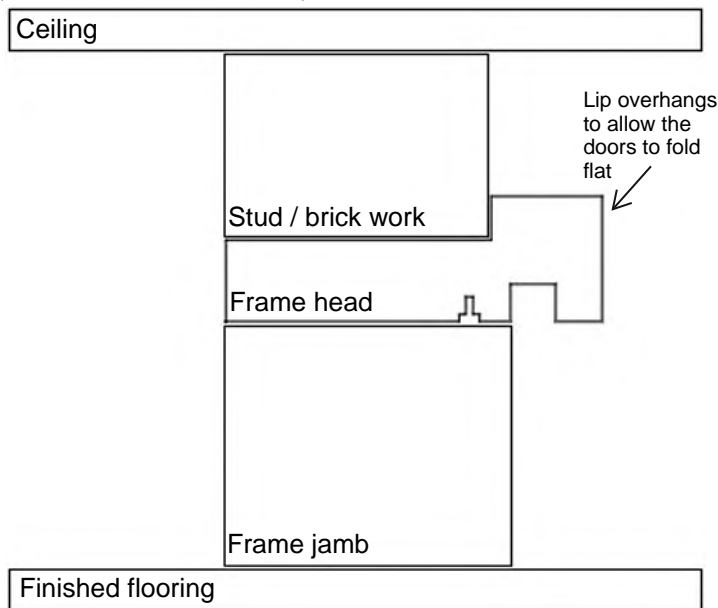

When you install the frame into your opening, the upstand on the frame head will wrap around the face of your stud / brickwork, as shown opposite.

The frame jambs should be installed ON TOP of your finished flooring. If they are not, the frame will need to be packed up to finished flooring height.

Secure the assembled frame into the brickwork / stud wall opening by countersinking Qty 5 direct frame fixings supplied in each jamb and Qty 3 in the frame head (unless the construction of your building requires more appropriate fixings to suit the individual dwelling).

Use the direct frame fixings (B) as follows;

- Use the 6.5mm x 148mm HSS drill (C) supplied to drill the holes in the frame jambs.
- Use the 6.5mm x 210mm SDS masonry drill (D) supplied to drill into the brickwork.
- Use the Torx T30 bit (E) supplied to screw in the direct frame fixings.
- Cover using the cover caps (F) provided or plug to your own personal choice.

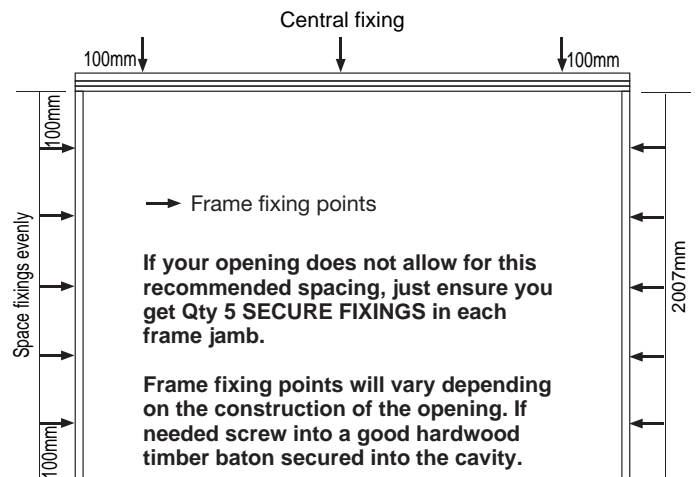

**Very important: Carefully check the frame is tightly fixed together and is square. Diagonals of the frame must be equal. Do not proceed with installation if the frame is not square.**

## Fitting the bottom pivots

Locate the top pivot (which has the plastic base.) The pivot fits into the machined slot in the frame head. Ensure the end of the pivot is level with the outside of the frame jamb, with the adjuster screw to the inside of the frame.

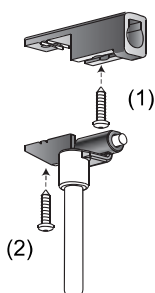

Top pivot with plastic base

Remove the centre part of the of pivot and screw the pivot base into the machined slot using the screw hole closest to the jambs (1.)

Then reinsert the centre part of the pivot into the machined slot using screw hole (2.)

Fix the top pivot block using Qty 2 dome headed Phillips screws provided and the PH2 bit (M).

## Fitting the bottom pivots (cont)

Locate the bottom pivot (which has the metal base.)  
The pivot must be fitted to the floor, tight up against the edge of the frame jamb and exactly level with the outside face of the frame jamb.

The bottom pivots and frame jambs should be fitted on top of your finished flooring. If your finished flooring is not down, you will need to pack the jamb and pivots up to the height of your finished flooring.

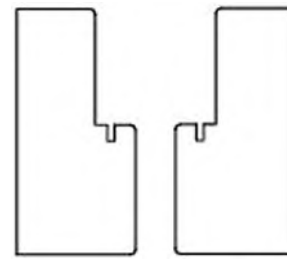

Bottom pivot location  
(Must be level with the outside edge of the frame jamb and tight against the face of the frame jamb.)

Left pivot

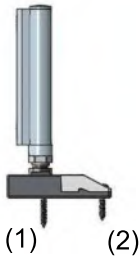

Right pivot



The bottom pivot should be fixed with the adjuster screw facing to the inside of the frame.

### Concrete or tile flooring

Remove the centre part of the pivot base, drill into the floor using the 7mm Masonry drill (G), using screw hole (1) closest to the jambs using the M4 x 40mm screws (H) and Pozi no.2 bit (I) (and plugs for concrete floors only.)

### Wooden flooring

Fix the bottom pivot block using Qty 2 dome headed Phillips screws provided and the PH2 bit (M).

**THE PIVOTS MUST BE INSTALLED completely LEVEL, with the pin UPRIGHT at 90 degrees, not leaning left or right.**

**IMPORTANT-** The pivot base must be securely fixed to the floor, as the bottom pivots take the weight of the doors.

The pivot centres must be installed so the small slot above the adjuster nut faces towards you and is accessible for adjustment.



The pivots enable lateral (side to side) adjustment for the doors. It is important any skirting or architrave stops at the end of the bottom pivot block, rather than being cut in / around the pivot block or pin, as this will restrict full range of adjustment. See opposite;



## Installing the pivot doors

Locate the Pivot door, Door 1.

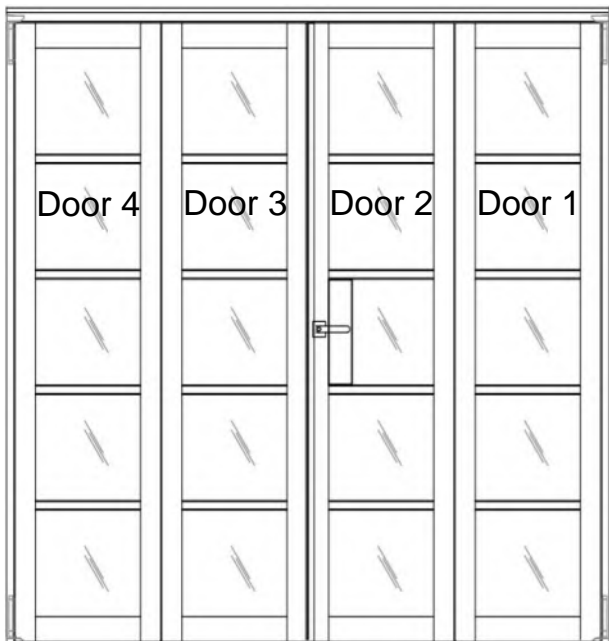

Fix the bottom pivot hinge plate **ONLY** onto the edge of the Pivot door, Door 1 using the torx screws provided and the 1/4 Hex T30 bit (E) into the predrilled holes.

Lift the door onto the bottom pivot by sliding the hinge plate over the bottom pivot pin. Support the door and slide the top pivot hinge plate over the pivot pin in the frame head, and then fix the top hinge plate to the edge of the door using the Torx screws provided into the pre-drilled holes.



Repeat the process for fitting Pivot door, Door 4.

Fit the half offset hinges to the inside edge of Door 1. Fix through the hinge plates using the torx screws provided and and 1/4 Hex T30 bit (E) into the pre-drilled holes.

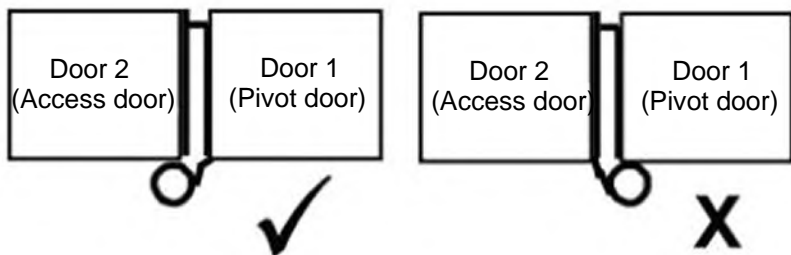

**VERY IMPORTANT**

Offset hinge barrels must be on Door 2 and Door 3, central opening doors.

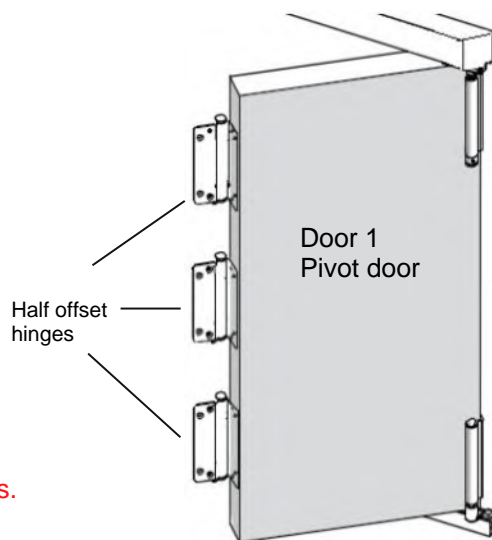

## Installing the Access door

Fix Door 2 the Access door, to Door 1, the Pivot door into the predrilled holes using the torx screws provided and the 1/4 Hex T30 bit (E).

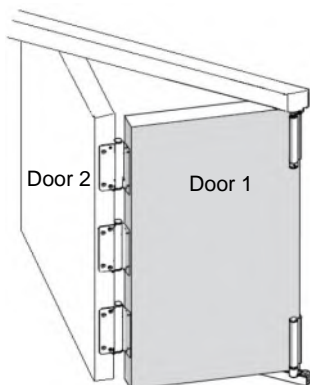

End cap

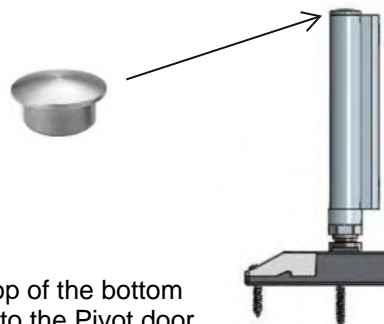

Fit the end cap to the top of the bottom pivot hinge barrel fixed to the Pivot door.

Use a rubber mallet taking extra care not to mark the door.

REPEAT THE PROCESS FOR FITTING DOOR 3.

## Fitting the tubular mortice latch and striker plate

Fit the tubular mortice latch into the pre-machined position in the Access door, using Qty 2 3/4" x 6s Pozi wood screws and Pozi No. 2 bit (I) provided.

The curved edge of the latch should face latch striker plate.

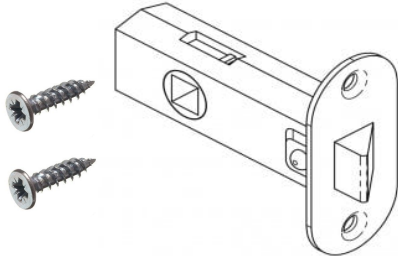

Fit the latch striker plate into the pre-machined position in the Middle door, Door 3 using Qty 2 3/4" x 6s Pozi wood screw and Pozi No.2 bit (I) provided.

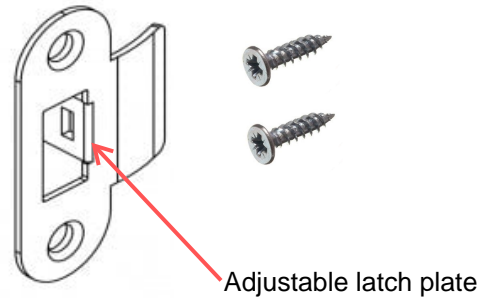

## Fitting the flush bolts and frame head keep

Fit the Qty 6 flush bolts into the pre-machined positions on the side edge of Doors 1, 3 & 4 doors using the 30mm Phillips screws supplied in with the bolts, Qty 2 screws per flush bolt and the PH2 bit (M) supplied.

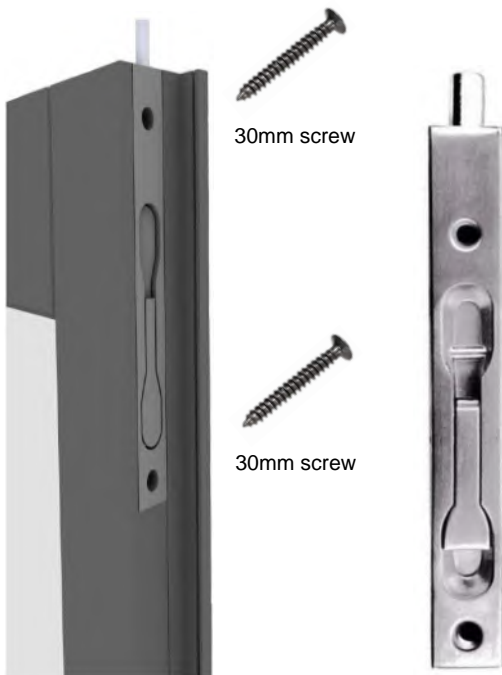

Fit the Qty 2 short bolt striker plates into the pre-machined positions in the frame head, using the 20mm Phillips screws provided in with the flush bolt and the PH2 bit (M).

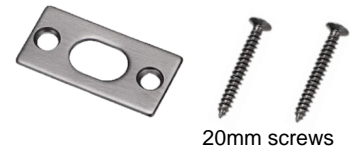

Fit the long flush bolt striker plate into the pre-machined position in the frame head, using the 20mm Philips screws provided in with the flush bolt and the PH2 bit (M).

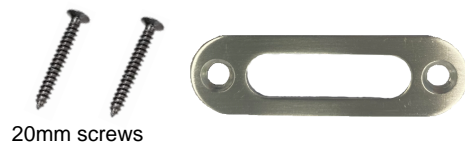

(View of Frame head, underside)

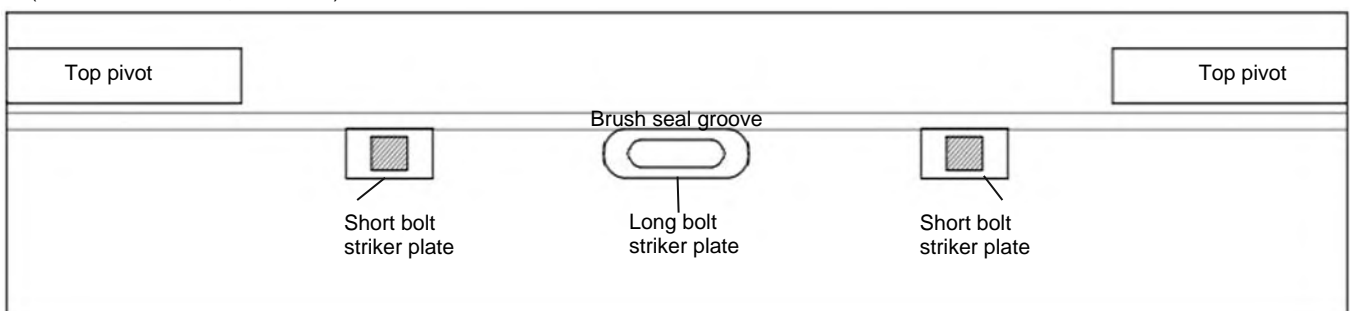

## Fitting the draft seals into the doors and frame

Fit the draft seals to the doors and frame as follows:

Qty 1 AQ21 to Door 1 & 4 Pivot doors.  
Qty 1 Bubble seal to Door 2 & 3 Access and Middle doors

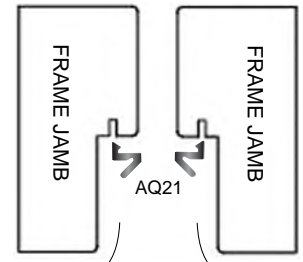
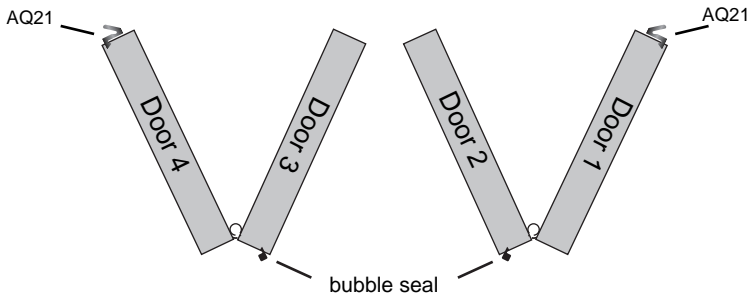

When fully open the doors will fold and stack against the wall on this side.

Qty 1 AQ21 to each frame jamb.

## Fitting the astragal mullion

The astragal mullion needs to be fitted to the Middle door, Door 3 which has been notched out to receive it.

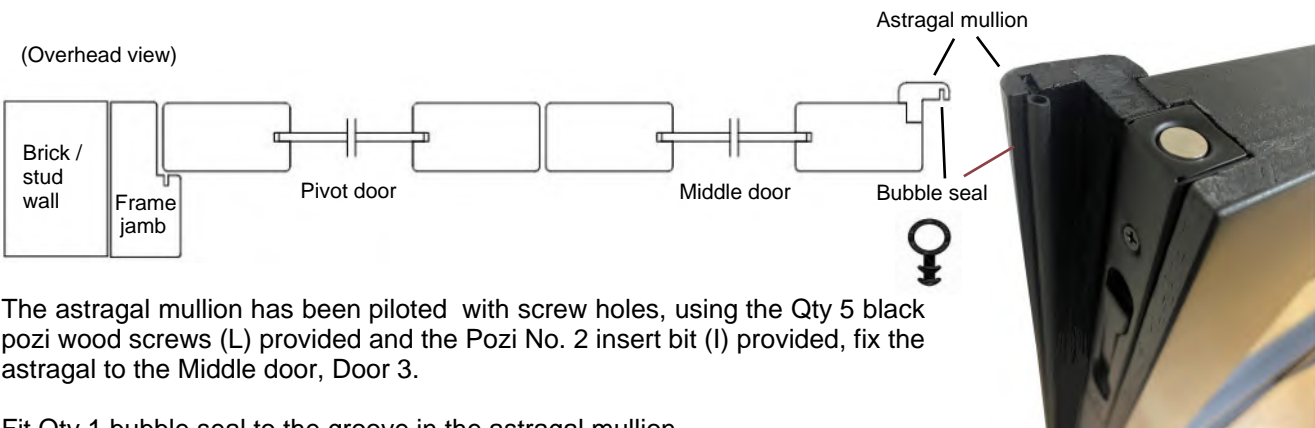

The astragal mullion has been piloted with screw holes, using the Qty 5 black pozi wood screws (L) provided and the Pozi No. 2 insert bit (I) provided, fix the astragal to the Middle door, Door 3.

Fit Qty 1 bubble seal to the groove in the astragal mullion.

## Adjustment of the doors

### Lateral adjustment

Carefully close the doors together and check how they are sitting in the frame.

Adjust the spacing between the doors and the frame jambs by turning the adjuster screws in the top and bottom pivots, using a long Phillips screwdriver.

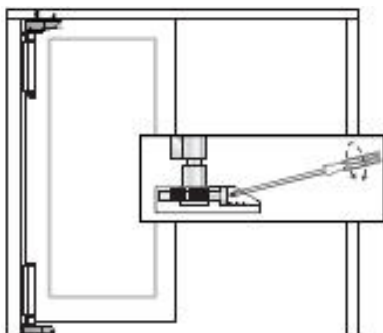

The opposite is the recommended spacing for our internal folding doors, however adjust the doors as required to achieve smooth operation.

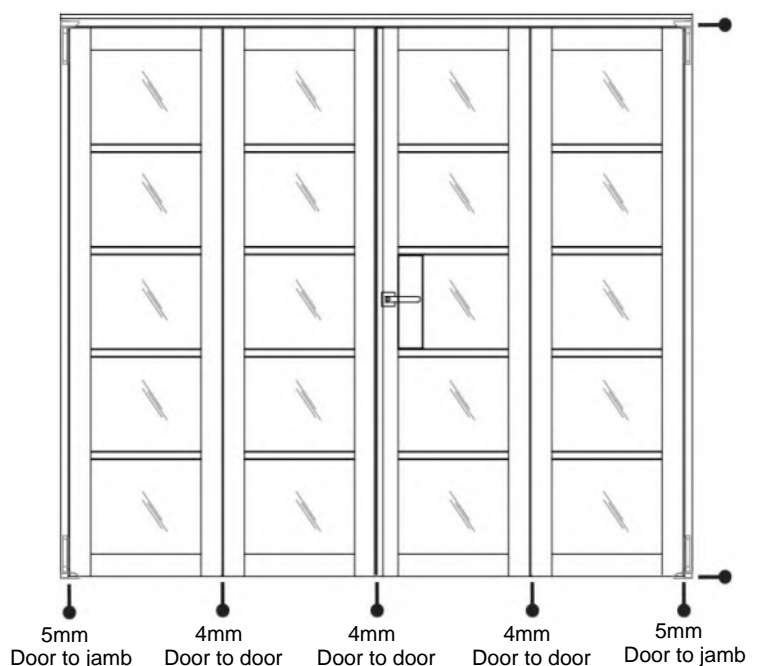

## Adjustment of the doors (cont)

### Height adjustment

Using the small screwdriver provided (J), insert the tip of the blade into the bottom of the pivot slot angling it downwards.

Use the blade to push the lock pin inside upwards to disengage it. With the blade still in place, use the 14mm spanner (K) provided, to turn the nut slightly. (Do not force the nut. Ensure the pin has been released before turning the nut.)

Clockwise will lift the door up, anti-clockwise will lower the door.

Remove the blade and continue to turn the spanner a full 360 degrees, at which point the pin will lock back into place.

Repeat this process should further height adjustment be required. One full turn will adjust the door height by 1.25mm, with a maximum adjustment of +/- 4mm.

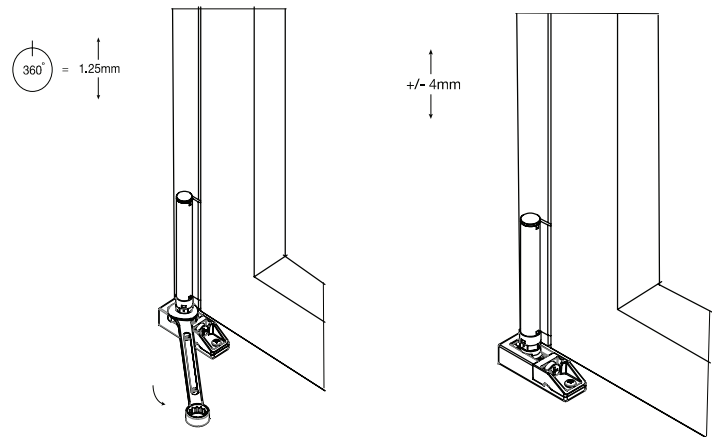
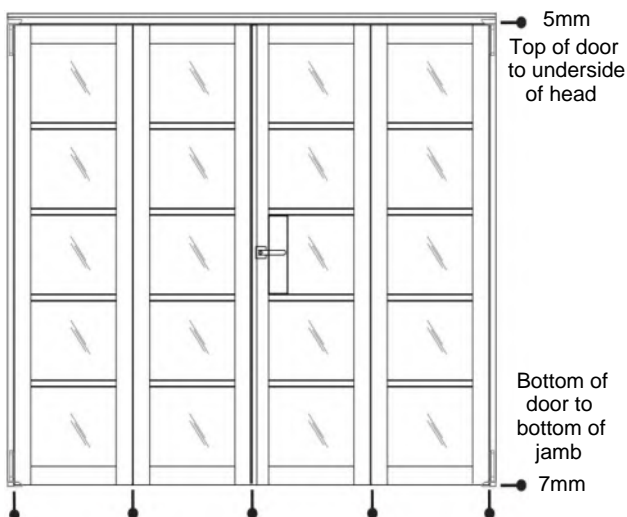
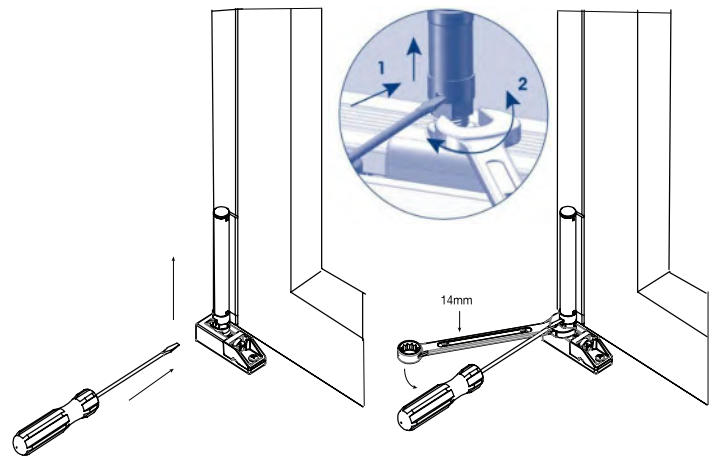

The opposite is the recommended spacing for our internal folding doors, however adjust the doors as required to achieve smooth operation.

## Fitting the striker plates for the bottom flush bolt

Once you are 100% happy the doors are correctly fitted and adjusted, you can now fit either the shorter squarer or the longer rounder striker plate into the finished flooring. To use the bottom flush bolt it will be necessary to make a locating hole in the floor, to be covered by the striker plate of your preference.

Using a bottom flush bolt provides greater rigidity when the doors are closed and it is our recommendation this is used. If however, it is preferred NOT to drill a hole into the floor, leaving the bottom flush bolt unused and the floor completely clear, please note well that the doors will be less rigid when closed and during operation. Not engaging the bottom flush bolt can also cause the doors to sit slightly out of line.



## Fitting the striker plates for the bottom flush bolt (cont)

Close both Pivot doors and engage the bottom flush bolts. Mark the flooring as to where the bolts would strike the flooring, and disengage the flush bolts. Before drilling the holes, please make sure the doors are not misaligned.

Short striker plate

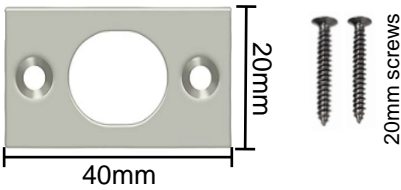

The Pivot door bottom flush bolts will each require;  
Qty 1 short striker plate  
Qty 2 20mm Phillips screws

Offer the striker plates to the floor and mark off accordingly with a pencil. Drill or route out a hole to allow the floor to receive the bolts. Secure the plates using Qty 2 20mm Phillips screws provided and the PH2 bit (M).

Long striker plate

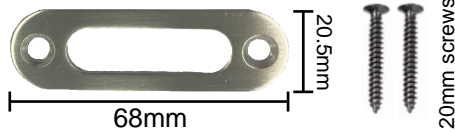

Repeat the process with the bottom flush bolt on the Middle door, Door 3 except this time use the long striker plate with Qty 2 20mm Phillips screws provided and the PH2 bit (M).

## Fitting the metal door holder

Fit the door holder to the same side which the Access door opens towards.

Fit the long metal 'male part' of the door holder to the Access door, Door 2, and the short metal receiver part of the door holder to the Pivot door, Door 1. Use the pozi screws provided with the door holder and the PZ2 bit (I). You can discard the plastic plugs. Repeat the process with Doors 3 & 4, fitting the long 'male' part of the door holder to the Middle door, Door 3, and the short metal receiver to the Pivot door, Door 4.

**IMPORTANT-** Take care to avoid the joints of the doors

Receiver fits to  
Pivot doors 1 & 4



Long 'male' part  
fits to Middle  
doors 2 & 3



We recommend the holder is fitted to the top of the doors to avoid tripping, however they could be fitted to the bottom if preferred.

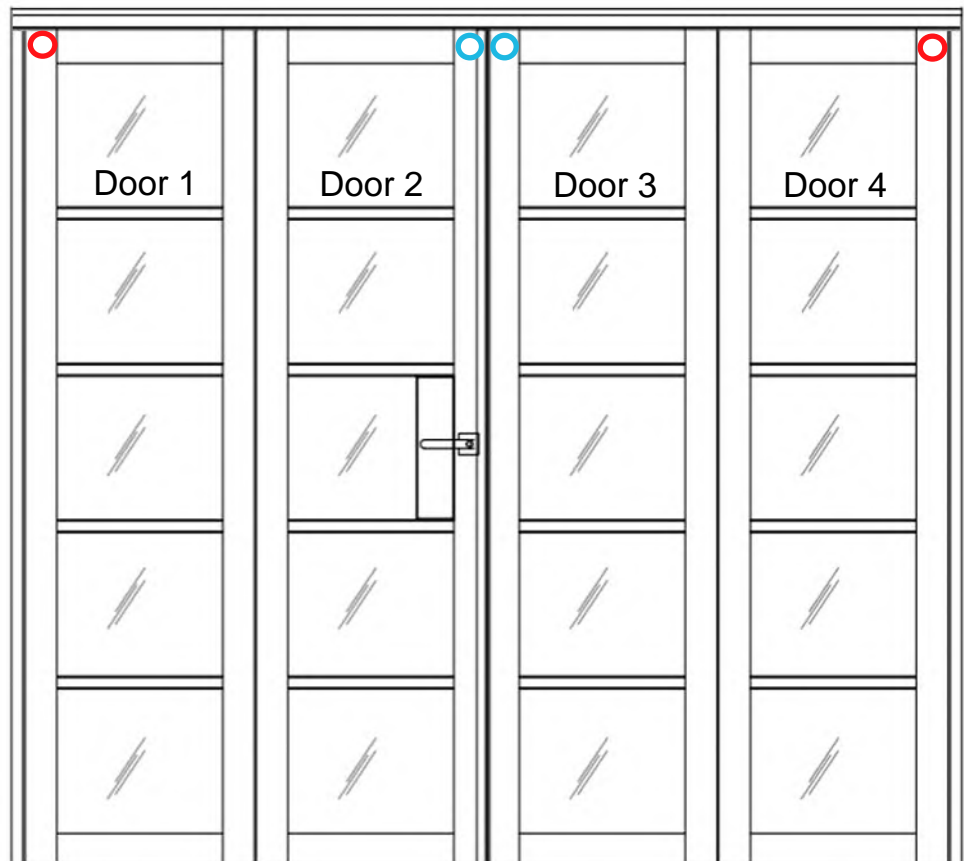

## Final finish

Due to increasing demands for thinner frame sections / slimmer sightlines, this can impact on the final finish surrounding the outer frame. The frame may sit flush to one side of the partition / reveal, leaving the other side of the frame set within the reveal or create gaps. It is a personal preference as to how you choose to finish up to the frame. You could foam fill and silicone seal any gaps, use a decorators caulk, plasterboard and plaster, or finish using an architrave to match the doors.

Should you wish to source any matching timber, the black prime plus doors (RAL 9011) internal folding doors sets are hardwood veneered and finished with a polyurethane finish. Unfortunately we are unable to supply any trims or architrave.

## Correct operation

To open the doors, first depress the handle on the Access door and fully open the door. Next, open the Middle door using the finger operated bolts located on the side edge of the door, release both the top and bottom bolts and open the door fully. This will expose the finger operated bolts located on the side edge of each Pivot door, release both the top and bottom bolts and then fully open the doors.

### Right opening

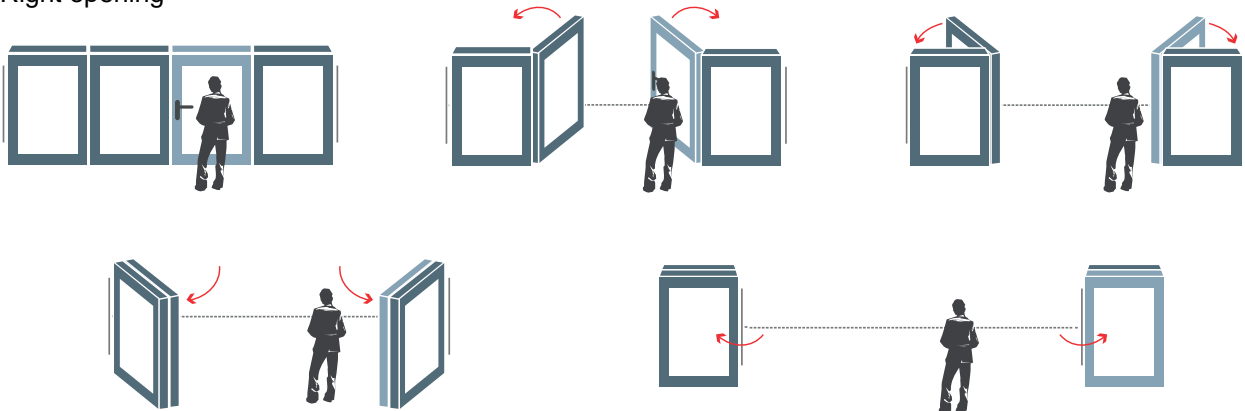

### Left opening

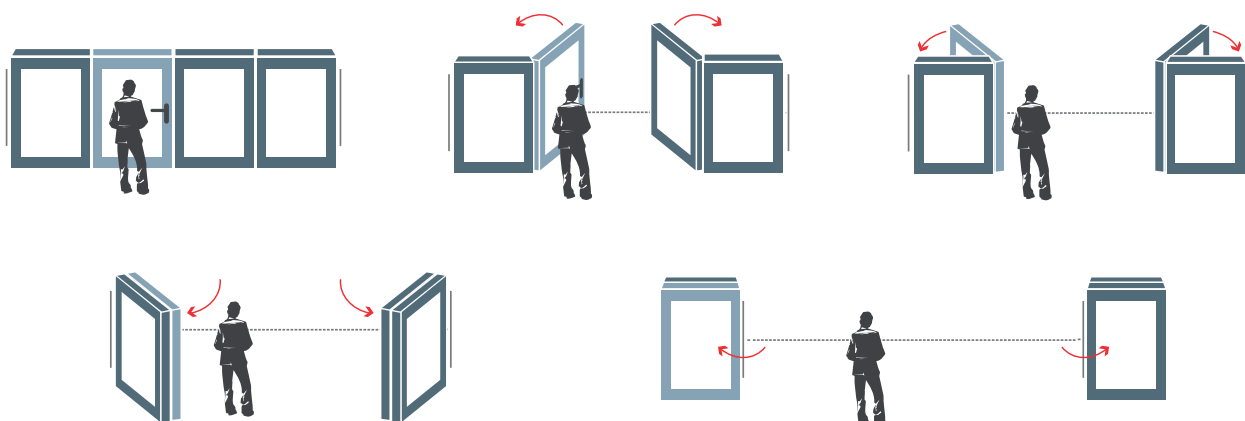

When closing the internal folding room divider door set, first close the Pivot doors, Door 1 & 4, securing in place using the top and bottom finger operated bolts located on the side edge of each door.

Once secured, close the Middle door, Door 3 using the top and bottom finger operated bolts, and then finally close the Access door by pulling or pushing the door until the central latch engages.